

# LightCHAIR, II



CE



Find this notice at:  
[www.logo-silver.fr](http://www.logo-silver.fr)

LIGHT, EFFICIENT AND PRACTICAL  
TO STORE OR TO TRANSPORT.

**LOGO** SILVER  
**EUROPE**

# CONTENTS

I.	INTRODUCTION .....	4
I.1	USAGE IN ACCORDANCE WITH THE INSTRUCTIONS.....	4
I.2	LIABILITY .....	5
I.3	INDICATIONS FOR REUSE.....	5
I.4	MAINTENANCE.....	5
II.	SECURITY .....	5
2.1	STANDARDS AND GUIDELINES.....	6
2.2	DECLARATION OF CONFORMITY.....	6
2.3	GENERAL SAFETY INSTRUCTIONS .....	7
2.4	TRANSPORT AND STORAGE SAFETY REQUIREMENTS .....	7
2.5	OPERATING SAFETY REQUIREMENTS.....	8
2.6	SAFETY REQUIREMENTS FOR MAINTENANCE, UPKEEP & DISPOSAL.....	9
2.7	USER REQUIREMENTS .....	9
2.8	SECURITY FUNCTIONS .....	10
2.9	WARNING SIGNS AND SIGNALS .....	10
2.10	ELECTROMAGNETIC INTERFERENCE.....	10
III.	STRUCTURE AND PERFORMANCE .....	11
3.1	ELECTRICAL DIAGRAM FOR THE LIGHTCHAIR II .....	11
3.2	STRUCTURE OF THE LIGHTCHAIR II.....	12
IV.	SPECIFICATIONS .....	13
V.	INSTALLING AND FOLDING .....	14
5.1	INSTALLATING .....	14
5.2	FOLDING .....	15
VI.	USAGE AND FUNCTIONALITY .....	15
6.1	USAGE .....	15
6.1.1	CONTROLLER .....	15
6.1.2	BATTERY USAGE.....	16

6.1.3 CHARGING THE BATTERIES.....	17
6.1.4 SURGE PROTECTION .....	17
6.1.5 BRAKE LEVER.....	17
6.1.6 SEATBELT .....	18
6.2 FUNCTIONALITY.....	18
6.2.1 PREPARATION BEFORE USE .....	18
6.2.2 TRAINING BEFORE USE.....	18
VII. DIAGNOSIS AND TROUBLE-SHOOTING.....	20
VIII. SAFETY DEVICES AND ACCIDENT MANAGEMENT .....	20
IX. UPKEEP.....	21
9.1 HUMIDITY.....	21
9.2 TEMPERATURE.....	21
9.3 GENERAL INSTRUCTIONS .....	21
9.4 UPKEEP AFTER USE .....	22
9.5 REGULAR CHECKS.....	22
9.6 CLEANING.....	23
9.7 DISINFECTING & RE-USING A POWER WHEELCHAIR .....	24
X. TRANSPORT AND STORAGE .....	25
XI. OPENING AND VERIFICATION .....	25
XII. GUARANTEE.....	26
XIII. DISPOSAL.....	27

# I. INTRODUCTION

These operating instructions provide the user, and those accompanying them, all the necessary knowledge concerning the construction and maintenance of the LIGHTCHAIR II.

This user's guide contains information necessary for the safe use of this electric wheelchair and provides indications allowing to find possible causes of malfunctions and how to eliminate them.

It is imperative to read the contents of this user's guide in order to use the LIGHTCHAIR II in complete safety. The user, and those accompanying the user must attentively read this user manual, particularly the chapter on security, before the first usage. This allows full use of the LIGHTCHAIR II's capacities.

## Pictograms and terms used as warnings:



### **DANGER !**

**Warning against physical danger and possible death**



### **WARNING !**

**Warning against possible material damage**



### **NOTE**

**Important information and advice**



### **ENVIRONMENTAL NOTE**

**Information for the protection of the environment**

## I.1 USAGE IN ACCORDANCE WITH THE INSTRUCTIONS

The LIGHTCHAIR II is designed for the individual use of people presenting with a total or partial motor disability of the lower limbs, allowing autonomous movement at home or outdoors on smooth surfaces.

Do not use the LIGHTCHAIR II on terrain with obstacles, mud or snow, on grass, shingle or in the rain.

The LIGHTCHAIR II should only be combined with the options mentioned in this user's manual and vice versa. The company Logo Silver, manufacturer of LIGHTCHAIR II, is not liable in the event of association with medical devices and / or accessories not included in the options list or from other manufacturers.

Any use other than that which is mentioned is considered to be non-compliant.

The responsibility for damage to people or to property resulting from non-compliant use is the responsibility of the user, not the manufacturer.

Only duly informed people are authorised to use the LIGHTCHAIR II. To be informed about the use of LIGHTCHAIR II constitutes one of the conditions which protects people from possible dangers and allows the correct and safe use of the LIGHTCHAIR II.

## I.2 LIABILITY

The manufacturer may only be held liable if the instructions for use, maintenance and servicing intervals of the LIGHTCHAIR II are respected. The manufacturer expressly states that only spare parts authorised by the manufacturer may be used. Logo Silver company declines all responsibility for damage resulting from the use of spare parts not authorized by the manufacturer as well as damage resulting from use not in accordance with the instructions. This warranty is subject to French civil and commercial law.

## I.3 INDICATIONS FOR REUSE

**The LIGHTCHAIR II has been designed to be reused.**

Like used machines or vehicles, reused products are subject to specific constraints. The modification of characteristics and performances must not, for the duration of the product, compromise personal safety.

Due to market observations and state of the art technical characteristics, the manufacturer has evaluated between 6 and 7 years for the duration of use of the LIGHTCHAIR II, provided that it is used in accordance with the instructions and that the care and maintenance instructions are followed. This duration does not take into account the storage times with the manufacturer or with the distributor. It should be noted that if the LIGHTCHAIR II is maintained in accordance with instructions, it remains reliable beyond the period defined above.

To be reused, the LIGHTCHAIR II must be thoroughly cleaned beforehand. Then, the condition, wear and damage of the LIGHTCHAIR II must be checked by an approved specialist. All worn or damaged parts as well as non-fitting components, or those not suitable for the new user should be replaced.

The maintenance manual contains a calendar of the maintenance operations to be carried out for each model as well as detailed information and the list of tools required.

## I.4 MAINTENANCE

If you have questions or have a problem that you cannot resolve despite the assistance provided by the operating instructions, please contact your dealer.



#### NOTE

LIGHTCHAIR II checks and repairs must be carried out exclusively by qualified personnel approved by the Silver Logo company. In the event of any problem, please contact the specialist dealer which sold you the product.

## II. SECURITY

### 2.1 STANDARDS AND GUIDELINES

All the safety information in this manual relates to the french legislation in force and the provisions of the European Union. In other countries, it is necessary to respect the corresponding legislations and provisions.

The LIGHTCHAIR II was manufactured in accordance with current technical regulations for safe operation. The safety of the LIGHTCHAIR II is certified by CE and its declaration of conformity.

### 2.2 DECLARATION OF CONFORMITY

As the manufacturer, Logo Silver declares under its responsibility that its product meets the requirements of European regulation MDR 2017/745 relating to class I medical devices (according to annex VIII chapter I 11 , rule 13).

The design, development and manufacturing of the LIGHTCHAIR II are fully compliant in terms of safety, by the following technical requirements:

- Risk analysis and management according to NF EN ISO 14971 standards
- Design requirements NF EN 12182 and NF EN 12184
- Dynamic stability, static stability, fatigue resistance test
- Product information: NF EN 12182 and NF EN 12184
- Advertising documentation, use and maintenance guide, labeling, defining of energy consumption, determination of speed, acceleration and deceleration, ability to climb the maximum slope safely, ability to mount obstacles.
- Compliance with standards NF EN 12184 means, among other things, that the required values for an inclination, the crossing of an obstacle, and speed, are reached or even exceeded by the LIGHTCHAIR II.

## 2.3 GENERAL SAFETY INSTRUCTIONS

- The LIGHTCHAIR II may only be used in conformity with the instructions.
- Only duly informed and authorized people may use the LIGHTCHAIR II
- Only one person may use the LIGHTCHAIR II at any given time.
- Other safety elements, belt and vest can be ordered as accessories from Logo Silver.
- All safety instructions contained in this user manual and in all valid associated documents must be observed and applied. This notice must be available to the user at all times.
- The fabric of the backrest and the cushion may, however unlikely, catch fire. The use of fire or a lit cigarette must be undertaken with extreme care.
- Beware of obstacle clearance when driving uphill and descending.
- Power level changes must be made while stationary.
- Make sure the joystick is securely attached and straight.
- Make sure the motor levers are unlocked in the «electric» position.
- Only original manufacturer options can be used. The optional components must be fitted exclusively as indicated below. Failure to respect this recommendation results in the loss of warranty.
- After removing special screws, nuts or washers; replace them if damaged and tighten them firmly.

## 2.4 TRANSPORT AND STORAGE SAFETY REQUIREMENTS

- The LIGHTCHAIR II is designed to be folded, and must be transported in this fashion, or in a transport case (sold as an optional extra by Logo Silver) in order to travel safely. The LIGHTCHAIR II must only be lifted by the elements of the chassis.
- During transport, the electrical part of the LIGHTCHAIR II must be switched off via the «On / Off» button.
- It is forbidden to travel seated in the LIGHTCHAIR II when transporting it.
- In order to guarantee the LIGHTCHAIR II's lifespan, it must be stored in a sheltered place.
- After each setting adjustment or modification made on the LIGHTCHAIR II, the mounting screws and nuts must be tightened securely.

## 2.5 OPERATING SAFETY REQUIREMENTS

- Before each use, the user must ensure that the LIGHTCHAIR II is in a safe condition and in accordance with the instructions, including the security functions.
- The operating and safety condition of the LIGHTCHAIR II must be checked at least once a year by an approved specialist.
- If errors, faults or other hazards are detected which might cause personal injury, the LIGHTCHAIR II must be taken out of service immediately.
- The LIGHTCHAIR II works only at temperatures between -10 ° C and+ 35 ° C. During operation, the LIGHTCHAIR II must not be exposed to temperatures outside the range of those indicated above.
- The maximum load supported by the LIGHTCHAIR II is 120 Kg. This weight must not be exceeded
- Before each use, a visual check must be carried out to verify that the tyre pressure is correct (see tyre inscriptions).
- When traveling on public roads, you must respect the road code.
- The power button should be 'off' when making transfers.
- Small obstacles must be crossed at a moderate pace (3 km / h) and preferably in a perpendicular fashion.
- Maneuvers may only be carried out at reduced speed.
- LIGHTCHAIR II may generate electromagnetic interference which may disrupt the proper functioning of other devices. It is therefore better to turn it off while not in use.
- In regard to tyres, please note the following:
  - - The tyres of the LIGHTCHAIR II contain chemical substances which may react with other chemicals (e.g. cleaning chemicals or acid).
  - - Direct exposure to sunlight (UV) accelerates tyre aging. This results in a hardening on the side of the tyre which cracks at the edges.
  - - Regardless of their wear, the tyres must be changed every 2 years.
  - - Prolonged non-use or significant heat on the tyres (if the LIGHTCHAIR II is near a heater or exposed to direct sunlight through a window) may deform them permanently . Ensure, therefore, to maintain a sufficient distance from heat sources.
- The LIGHTCHAIR II can be driven on inclinations and descents of 9°, you must not attempt steeper ascents or descents.
- While driving downhill, for security reasons, speed should be reduced.  
Charging the batteries can produce explosive gases. Which is why it is necessary to take the following safety measures while charging:
  - Switch off the LIGHTCHAIR II
  - Ensure the room is ventilated
  - It is forbidden to smoke or to start a fire. It is imperative to avoid sparks.



## 2.6 SAFETY REQUIREMENTS FOR MAINTENANCE, UPKEEP AND DISPOSAL

- LIGHTCHAIR II maintenance must be carried out by qualified personnel, approved by Logo Silver. This also applies to all repairs and settings.
- The On / Off button must be switched off and the batteries removed for all maintenance.
- The LIGHTCHAIR II may be cleaned with a wet sponge (avoid detergents).
- Defective batteries must be returned to distributors or Logo Silver in order to be recycled in accordance with environmental specifications.

## 2.7 USER REQUIREMENTS

- The use of LIGHTCHAIR II is reserved for capable users. Which is why the user must be instructed by qualified personnel, approved by Logo Silver in order to drive the LIGHTCHAIR II.
- The user must have read and understood this user manual completely.
- It is forbidden to use the LIGHTCHAIR II in case of significant fatigue, or under the influence of alcohol or medicine.
- Before the first use, practice driving the LIGHTCHAIR II on level ground and with good visibility, then increase the difficulties, by crossing small obstacles, descents and climbs. This training helps avoid dangerous situations.



### **DANGER!**

**If your wheelchair moves involuntarily, release the joystick immediately and the chair will stop automatically. In the event of a joystick or brake malfunction, turn off the power-supply.**

## 2.8 SECURITY FUNCTIONS

In case of danger, the LIGHTCHAIR II can be switched off at any time with the On / Off button. The charger will automatically shut off as soon as the batteries are charged.

## 2.9 WARNING SIGNS AND SIGNALS

**LOGO SILVER**  
**EUROPE**

163 cours Berriat  
38000 Grenoble / France

REF: LIGHTCHAIR II

SN: 0000001

01/2020

CE MD

120 kg max. 9° max.

- Reference
- Serial number
- Fabrication date
- CE approval
- Medical device
- Read the instructions before use
- Maximum slope
- Maximum user weight

## 2.10 ELECTROMAGNETIC INTERFERENCE

Your wheelchair may travel in areas affected by electromagnetic interference or signals from certain transmitters such as radio, wireless intercoms, cell phones, speed cameras, etc. In which case, your driving may be disrupted. Electromagnetic interference can modify the electric wheelchair's control system. Certain disturbances may cause brake-failure, involuntary movements, as well as irreversible damage to the control system.

### Electromagnetic interference classification

- Short-band radio transceiver. Such as radio waves in urban areas, walkie-talkies, mobile telephone networks and signal transmissions of communication devices.
- Medium-band mobile radio transceiver. These are usually installed in a building or vehicle. For example: police, fire department, taxi, ambulance and other radio transceivers.
- Broadband radio transceiver. These are usually installed in a tower, such as commercial radio or TV transmission systems.



### WARNING!

The wheelchair and battery charger comply with the following code standards: GB / T 18029.21 Wheelchair - Part 21: Requirements and test methods for electromagnetic compatibility.



### WARNING!

Electromagnetic interference (EMI) can affect the driving of the chair. This interference can come from mobile phones, radio transmitters, TV...

### Preventing electromagnetic interferences

- Do not use portable radio transceivers such as cell phones, radios, etc. when the wheelchair is on.
- Avoid driving near radio transmission systems such as radio and television transmitters.
- If the electric wheelchair or its brakes are faulty, please contact your distributor.

## III. STRUCTURE AND PERFORMANCE

### 3.1 ELECTRICAL DIAGRAM FOR THE LIGHTCHAIR II

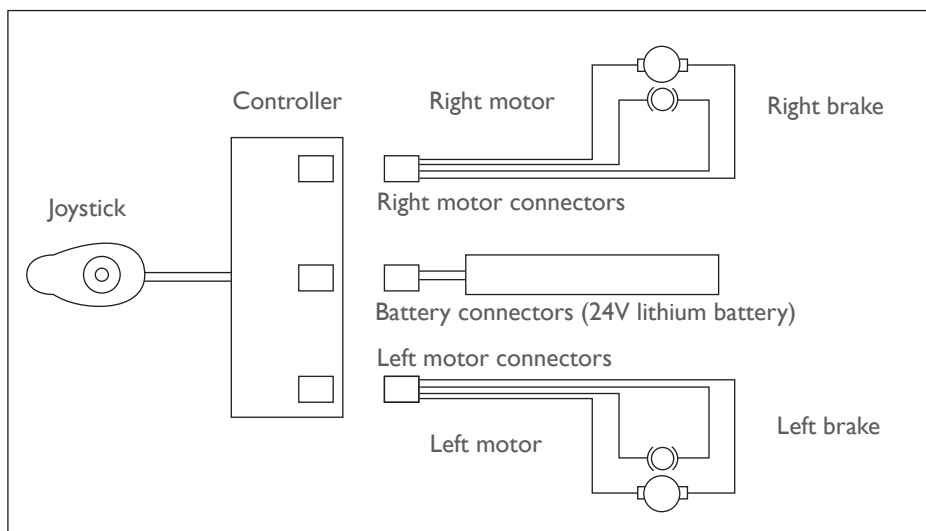

## 3.2 STRUCTURE OF THE LIGHTCHAIR II

The LIGHTCHAIR II is composed of the following main parts: the front and rear wheels, the chair frame, joystick, motor, armrests, handlebar, backrest, seat, footrest, battery housing and charger. See fig. 1



fig. 1

## IV. SPECIFICATIONS

The principal specifications including the dimensions and weight.

Accessibility	Inside and outside on smooth surfaces / class B
Configuration	2 motorised rear wheels
General dimensions	length: 1000 mm with footrest
	width: 630 mm
	height: 960 mm
Folded wheelchair dimensions	370 mm x 630 mm x 770 mm
Seat height	510 mm
Seat width	470 mm
Seat depth	450 mm
Armrest height	from 190 to 250 mm
Backrest height	450 mm
Backrest tilt	22° to 43°
Seat tilt	not tilting
Battery weight	3,6 kg
Wheelchair weight	29 kg with batteries
Maximum user weight	120 kg
Maximum speed	6 km / h
Braking distance	100 cm
Turning radius	100 cm
Half-turn with	110 cm
Static stability	9°
Dynamic stability	6°
Slope ability	6°
Maximum slope	9°
Obstacle clearance	4 cm
Autonomy	20 km
Motors	200W x 2
Lithium batteries	10Ah C5 x 2
Electronics	MICON
Battery charging	External and by joystick
Front wheels	200 mm
Rear wheels	300 mm
Camber wheels	0°
Suspension	Front wheels

# V. INSTALLING AND FOLDING

## 5.1 INSTALLATION

- Take the wheelchair out of the box and put it on the floor. Install the batteries by inserting them into the housing (fig. 3).
- Place the joystick on the armrest (fig 4) and lower the tightening key onto the controller to attach it (fig. 5).
- To remove the battery (fig. 7): hold the “A” then pull the “B”.
- Put the engine lock lever in «electric» mode to ensure the wheelchair is not in manual mode. (fig. 6)
- Press the backrest adjustment button with two fingers to move the backrest forwards or backwards (fig. 8).

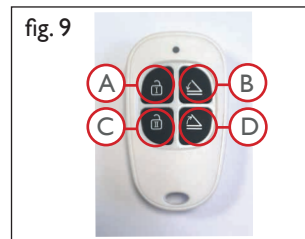
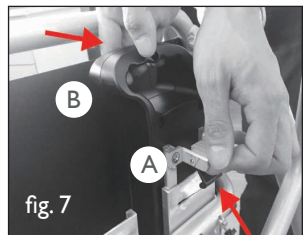
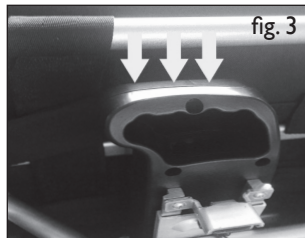
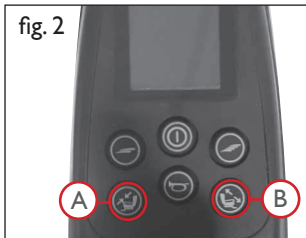

## 5.2 FOLDING

The LIGHTCHAIR II can be folded up for storage or transport. Before folding the chair, fully unfold the pallet.

- To fold with the joystick (fig. 2): press button A for 3 seconds to fold, and button B to unfold.
- Folding with the remote control (optional) (fig. 9): press buttons A and C, then B to fold and D to unfold the chair.



**DANGER!**  
Do not fold the chair when someone is sitting in it: risk of serious injury.

# VI. USAGE AND FUNCTIONALITY

When the engine lock lever is pulled down, it is in manual mode, which means that the chair may be pushed manually by a third party. When in electric mode, it cannot be pushed manually. (Fig.6)

## 6.1 USAGE

### 6.1.1 Controller

This is the key element of a wheelchair. It allows the control of all electronic functions (fig. 10). The controller is usually installed on an armrest and connected to a motor and a battery in its housing.

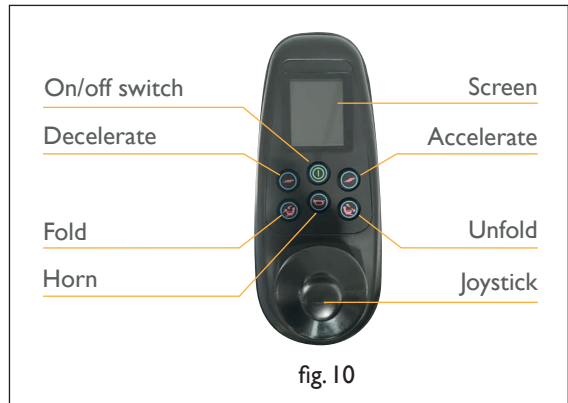

fig. 10

- On/off switch: the switch powers the electronic function control system and wheelchair motors. Do not use the switch to stop the chair except in an emergency. Otherwise, it may shorten the life of the chair components and cause violent braking.

- Joystick: the joystick is used to control the movements of the wheelchair, including its speed and direction (forwards, backwards, left or right, etc.). The more you push the joystick forward from its central position, the more quickly the wheelchair moves. Each time you release the joystick, it automatically returns to the center and the brake automatically stops the wheelchair.
- Horn: the horn sounds if you press this button.
- Acceleration / deceleration buttons and speedometer: after turning on the wheelchair the speedometer indicates the current maximum speed setting. This can be adjusted by the user by using the same button.
- Charger socket: the socket should only be used for this wheelchair. Do not use the plug to power other electrical devices. Otherwise, it could damage the chair's control system or its E.M.C performance (electromagnetic tolerance).



**NOTE**

If your wheelchair accidentally moves, immediately release the joystick and the chair will stop automatically.



**WARNING!**

If you connect devices to the outlet other than the supplied battery charger, damaging the control system, the warranty will be canceled.

**6.1.2 Battery usage**

Fully charge the batteries before the first use. This brings the batteries to approximately 90% of their capacity.

Upon the second battery charge (8-14 hours) they will obtain more than 90% of their capacity. After four or five charge charge-cycles, the batteries will recharge to 100% and will last longer. Please replace the batteries in case of failure. The old batteries must be returned to the supplier to avoid unnecessary pollution of the environment.

Battery specification	
Type	Lithium CS battery
Dimensions	330 mm x 105 mm x 65 mm
Voltage	24V
Capacity	2x10Ah





**WARNING!**

Do not use your wheelchair when the temperature is below  $-10^{\circ}\text{C}$  or above  $50^{\circ}\text{C}$ .

**WARNING!**

The 24V / 2A charger supplied by the manufacturer meets the requirements mentioned in Section I “General safety requirements” of GB9706.1- 2007 electric medical equipment. The battery must be charged with the charger supplied. Any other type of charger is not allowed.

**DANGER!**

Never let the battery freeze, do not charge a freezing battery, this could cause injury and damage the battery.

### 6.1.3 Charging the batteries

The battery charger is an important part of the wheelchair. The external charger connected to this product allows to charge the battery quickly and to easily optimize the use of your wheelchair.

Charging the battery using the provided external charger:

- Make sure the joystick is turned off and the wheelchair is in driving mode.
- Connect the 3-pin charger output plug to the joystick. (Fig.11)
- Connect the charger’s power plug to a standard wall outlet.
- The orange LED on the charger indicates that charging is in progress. The green LED on the charger turns on when the battery is fully charged.
- We recommend charging the battery for 8 to 12 hours
- Remove the charger and power plug when the battery is fully charged and store them in the bag behind the backrest.

### 6.1.4 Surge protection

The fuse, located at the back of the wheelchair, is designed for the safety of the wheelchair user. When there is a power surge, the fuse cuts the current. If the fuse is tripped, replace it with an identical 12-24V 30A model.

### 6.1.5 Brake lever

When you want to stop, release the joystick and the wheelchair will stop immediately.

### 6.1.6 Seatbelt

For your safety, the seat-belt must be fastened before driving the wheelchair. (fig. 12)

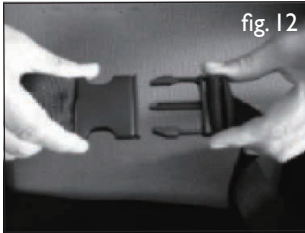

## 6.2 FUNCTIONALITY

### 6.2.1 Preparation before use

- Turn power off before any and all transfers
- Verify that the brakes function correctly
- Fold the footrest pallet then hold the armrest to sit in the wheelchair.
- Do not get out of the wheelchair by pressing on the footrest palate. Otherwise, the chair may tip over.

### 6.2.2 Training before use

- Find a spacious place like a public square and ask an assistant to help you practice until you have enough confidence to use the LIGHTCHAIR II alone.
- Press the power button on the joystick, the battery light will come on.
- Choose the lowest speed until you can use the wheelchair with confidence.
- Push the joystick forward, observe the movement of the wheelchair, then push it in all directions and observe the rotation of the wheels.
- Release the joystick and observe that the wheels stop turning.



#### **WARNING!**

Turn the power off when climbing in and out of the wheelchair.

- When you are capable, you can test S-turns. Once familiar with 'S' turns, you can reverse while paying attention to the speed setting. Reverse speed must be less than forward speed.

fig. 13

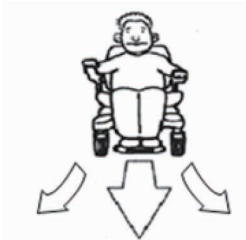
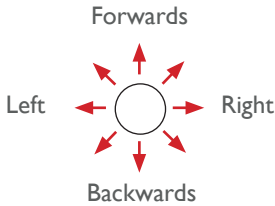

Joystick with remote control option:



**DANGER!**

Do not use your wheelchair in manual mode except with the help of an assistant. Otherwise, it could cause injury.



**DANGER!**

Do not put your wheelchair in manual mode while it is on a slope. Otherwise, the wheelchair could descend the slope and cause injury.

## VII. DIAGNOSIS & TROUBLE-SHOOTING

For your convenience, this product has an automatic fault warning function. In the event of a malfunction, the indicator lights on the controller flash and the horn sounds. You can identify a fault using the information in Table. If the problem persists after inspection of the fault, do not use the wheelchair. Turn it off and contact your dealer.

LED*	Anomaly Diagnosis	Breakdown location
1 LED lit	Weak battery	Charge the battery.
2 LEDs lit	Left motor anomaly	Check the motor and its connections.
3 LEDs lit	Left brake anomaly	Check that the brake lever is in the correct position and if the braking is damaged.
4 LEDs lit	Right motor anomaly	Check the motor and its connections.
5 LEDs lit	Right brake anomaly	Check that the brake lever is in the correct position and if the braking is damaged.
6 LEDs lit	Control box overload	Check if the brake is removed and if the wheels are locked.
7 LEDs lit	Joystick anomaly	Check that the joystick is in the central position.
8 LEDs lit	Control box anomaly	Control box malfunction.
9 LEDs lit	Control box anomaly	Control box malfunction.

\* Joystick with remote control option



### WARNING!

In order to guarantee the quality of the electric wheelchair, please contact your dealer to replace the spare parts such as batteries, tyres, controller, motors and charger. Maintenance must be carried out by the dealer.

## VIII. SAFETY DEVICES AND ACCIDENT MANAGEMENT

- Fuse: please refer to 6.1.4 Surge protection
- Safety belt: please refer to 6.1.6 Safety belt
- Release the joystick in case of failure: the wheelchair will stop

# IX. UP-KEEP

Your electric wheelchair requires regular maintenance. Some checks can be carried out by yourself, others, by your dealer. Preventive maintenance is very important. If you follow the maintenance instructions in this section, your wheelchair will work for years without a problem. If you have any doubts about the up-keep or the operation of your wheelchair, please contact your dealer or our after sales service.

## 9.1 HUMIDITY

Your wheelchair, like most electrical and mechanical equipment, is sensitive to external conditions. Avoid humid environments. Direct or prolonged exposure to water or moisture as this could cause electronic and mechanical failure. Water can corrode the electrical components and the frame of the chair.

## 9.2 TEMPERATURE

In extremely cold weather, the battery may freeze. Unusual temperatures may cause many components such as the charger and battery (batteries sealed with lead-acid or gel batteries) to freeze. Temperatures above 55° C may slow your wheelchair.

## 9.3 GENERAL INSTRUCTIONS

- Avoid bumping the controller, especially the joystick.
- Avoid prolonged exposure of your wheelchair to extreme conditions, like hot, cold or humid environments
- Keep the controller clean
- Check all electrical connections, including cable and charger, and make sure they are all tightly secured.
- If only the red LEDs are lit on the battery meter, you must recharge the batteries as soon as possible, for 8 to 12 hours.



### **DANGER !**

**Never charge a cold or frozen battery, this may damage the battery and risks explosion.**

- The surface of the wheelchair chassis has a protective coating. You can apply a light coat of car wax to maintain its shine.
- Check the cables. Make sure they are connected and that they are not corroded. The battery should be placed in the battery area, flat, with the plug facing inwards.
- All wheel bearings are lubricated and sealed. There is no need to lubricate.
- Check for loose parts, such as the wheel axle, bearing and the chair itself. If they are loose, tighten securely.

## 9.4 UP-KEEP AFTER USE

- Switch off your wheelchair and disconnect all connectors if it is not in use for a long time.
- Prohibit children and neglectful people from using the wheelchair.
- Store the chair at normal temperatures to prevent deformation and maintain its performance for a long time.
- Clean and dry the wheelchair with a clean, soft cloth. Never use chemicals to clean it (to prevent warping and discoloration).
- Remove the fabric cover from the seat for washing. Dry before use.

## 9.5 REGULAR CHECKS

In order to maintain the good condition of your wheelchair, you should check it before each use. To carry out the weekly, monthly and twice-yearly checks, see table.

Parts and functions to inspect	Each use	Every week	Every month	Twice per year
All parts			•	
Joystick	•			
Braking system	•			
Connection		•		
Battery condition	•			
Tyre condition			•	
Chassis condition				•
Front wheel condition		•		
cleanliness	•			



#### NOTE

Only spare parts from Logo Silver may be used. Failure to comply with this condition results in loss of warranty. If you have any problems during maintenance, consult your dealer. The LIGHTCHAIR II must be checked once a year by qualified personnel approved by Logo Silver.

## 9.6 CLEANING

- The LIGHTCHAIR II must be cleaned regularly regardless of use or the degree of dirtiness.
- Never wash the wheelchair with water or expose it directly to water.
- The chassis surface has a protective coating. You must use a cloth moistened with soapy water to clean it, then dry completely.



#### WARNING!

Never use chemicals to clean the seat or armrests or you risk damaging the material or making it slippery.



#### WARNING!

Risk of damage to the electronic system! Risk of dysfunction !  
When cleaning the LIGHTCHAIR II, water should never come into contact with electronic components and batteries.



#### WARNING!

Do not use aggressive cleaning agents, solvents or hard brushes.

## 9.7 DISINFECTING & RE-USING A POWER WHEELCHAIR

Prior to the wheelchair being re-used (passing on to another user), it must be carefully cleaned and disinfected. All surfaces which come into contact with the user must be treated with a disinfecting product.

Many disinfecting products are commercially available and must be used according to the manufacturer's instructions. Before using any products on the wheelchair, test on a small area to ensure the disinfecting product is compatible with the wheelchair materials.

**LOGO SILVER recommends using one of the following solutions:**

- (AHP) Accelerated Hydrogen Peroxide disinfectant-based solution.
- Rapid alcohol-based solution
- Alkyl Dimethyl/Dimethyl ethyl benzyl ammonium chlorides-based solution.



**WARNING!**

Do not use solvents, bleaches, abrasives, synthetic detergents or aerosols.

Disinfectants may be used in dilution as specified by the manufacturer.

Ensure surfaces are rinsed with clean water and dried thoroughly.

Always read the label on any commercial or domestic cleaning substances.

Always follow the instructions carefully.



**WARNING!**

LOGO SILVER takes no responsibility for the effectiveness of the disinfecting process, for contamination, cross infection or damage to the product.



# X. TRANSPORT AND STORAGE

- The wheelchair may be transported folded or unfolded.
- Your wheelchair must be stored in a dry place, sheltered from extreme temperatures and humidity.
- Remove the batteries before storing it. Otherwise, the structure may rust and electrical components may be damaged.



**DANGER!**

When transporting the chair, folded or not, it is recommended to strap to the vehicle's tie-down rings.



**DANGER!**

The wheelchair must not be used as a seat in a vehicle.

# XI. OPENING AND VERIFICATION

Upon reception, verify that the carton is complete and that there are no damaged parts.

Packing list:

N°	Name	Quantity	Note
1	Electric wheelchair	1	Model:W5517
2	Charger	1	Model: HP0060WL2/60 HZ 24V2A
3	User manual	1	
4	Controller	1	

## XII. GUARANTEE

The wheelchair is guaranteed for a period of 2 years from the date of delivery, excluding corrosion, worn parts (tyres etc.), when used in compliance with the instructions. The batteries are guaranteed for 1 year.

- The warranty covers any construction or quality defect in the raw materials or components, under normal conditions of use (except normal wear of parts).
- The warranty is limited to the free repair or exchange of parts and sub-assemblies recognized as defective (parts, labor and transport), after inspection by an authorized representative.
- Warranty repairs must be authorized and performed by an approved supplier. Do not return parts without obtaining prior authorization.

### WARRANTY EXCLUDED

- Accidents or accidental impacts,
- Negligence,
- Abnormal usage,
- Inappropriate maintenance,
- Modifications carried out without the authorisation of the manufacturer,
- Use not in accordance with the instructions in the user guide supplied with the product or that does not meet product specifications,
- A removal or erasing of the serial number,
- Cold storage or batteries left completely discharged for a long time.

## XIII. DISPOSAL

- Respect the provisions in force in your country for the protection of the environment.
- Batteries that are no longer used are taken back by your dealer or by Logo Silver.
- The LIGHTCHAIR II may be returned to Logo Silver for recycling.

163 cours Berriat - 38000 Grenoble - France  
+33 (0)4 76 21 22 19  
contact@logo-silver.fr  
www.logo-silver.fr



### ENVIRONMENTAL NOTE

To discard the LIGHTCHAIR II, remove all components and materials respecting the environment and in accordance with the waste sorting instructions in force.

LightCHAIR II

by

LOGO SILVER  
EUROPE

Logo Silver Europe

163 cours Berriat - 38000 Grenoble - France  
Tél. +33(0)4 76 21 22 19 - [contact@logo-silver.fr](mailto:contact@logo-silver.fr)

[www.logo-silver.fr](http://www.logo-silver.fr)